

LP2956/LP2956A

Dual Micropower Low-Dropout Voltage Regulators

General Description

The LP2956 is a micropower voltage regulator with very low quiescent current (170 μ A typical at light loads) and very low dropout voltage (typically 60 mV at 1 mA load current and 470 mV at 250 mA load current on the main output).

The LP2956 retains all the desirable characteristics of the LP2951, but offers increased output current (main output), an auxiliary LDO adjustable regulated output (75 mA), and additional features.

The auxiliary output is always on (regardless of main output status), so it can be used to power memory circuits.

Quiescent current increases only slightly at dropout, which prolongs battery life.

The error flag goes low if the main output voltage drops out of regulation.

An open-collector auxiliary comparator is included, whose inverting input is tied to the 1.23V reference.

Reverse battery protection is provided.

The parts are available in DIP and surface mount packages.

Features

- Output voltage adjusts from 1.23V to 29V
- Guaranteed 250 mA current (main output)
- Auxiliary LDO (75 mA) adjustable output
- Auxiliary comparator with open-collector output
- Shutdown pin for main output
- Extremely low quiescent current
- Low dropout voltage
- Extremely tight line and load regulation
- Very low temperature coefficient
- Current and thermal limiting
- Reverse battery protection

Applications

- High-efficiency linear regulator
- Low dropout battery-powered regulator
- μ P system regulator with switchable high-current V_{CC}

Block Diagram

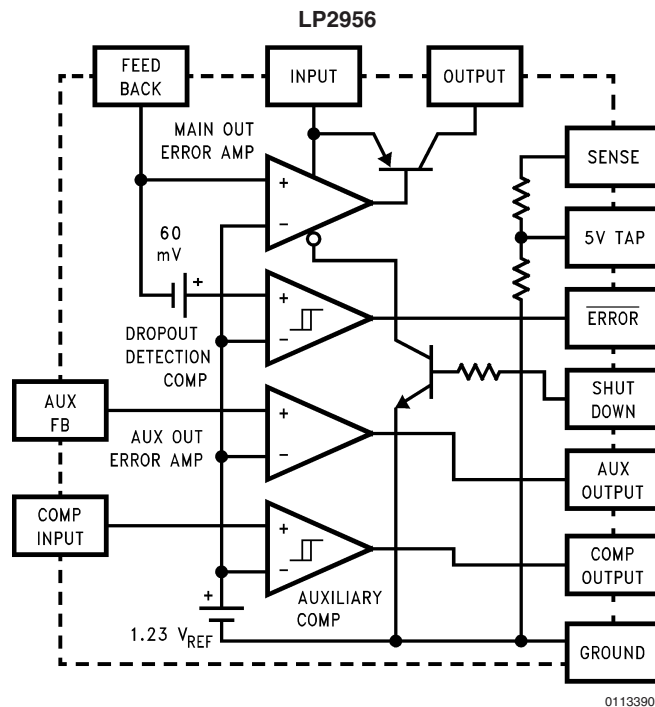

Connection Diagrams

16-Pin DIP

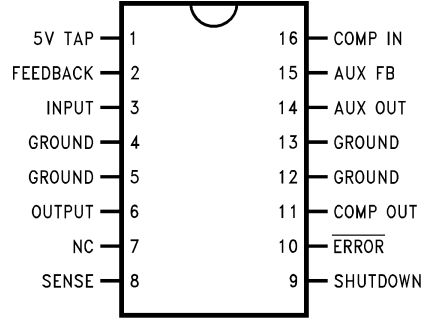

01133902

Order Number LP2956IN or LP2956AIN
See NS Package Number N16A
Order Number LP2956AMJ-QML or 5962-9554701QEA
See NS Package Number J16A

16-Pin Surface Mount

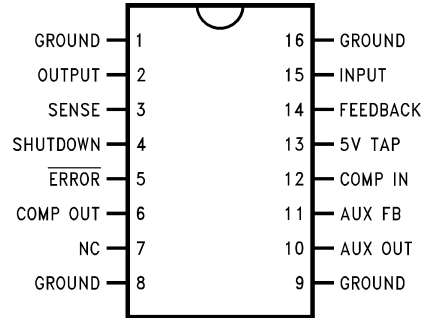

01133903

Order Number LP2956IM or LP2956AIM
See NS Package Number M16A

Absolute Maximum Ratings (Note 1)

If Military/Aerospace specified devices are required, please contact the National Semiconductor Sales Office/Distributors for availability and specifications.

Storage Temperature Range	-65°C to +150°C
Operating Junction Temperature Range	-40°C to +125°C
Lead Temperature (Soldering, 5 seconds)	260°C
Power Dissipation (Note 2)	Internally Limited

Input Supply Voltage	-20V to +30V
Feedback Input Voltage (Note 3)	-0.3V to +5V
Aux. Feedback Input Voltage (Note 3)	-0.3V to +5V
Shutdown Input Voltage (Note 3)	-0.3V to +30V
Comparator Input Voltage (Notes 3, 4)	-0.3V to +30V
Comparator Output Voltage (Notes 3, 4)	-0.3V to +30V
ESD Rating (Note 16)	2 kV

Electrical Characteristics

Limits in standard typeface are for $T_J = 25^\circ\text{C}$, and limits in **boldface type** apply over the full operating temperature range. Limits are guaranteed by production testing or correlation techniques using standard Statistical Quality Control (SQC) methods. Unless otherwise specified: $V_{IN} = 6\text{V}$, $C_L = 2.2\ \mu\text{F}$ (Main Output) and $10\ \mu\text{F}$ (Auxiliary Output), Feedback pin is tied to 5V Tap pin, $C_{IN} = 1\ \mu\text{F}$, $V_{SD} = 0\text{V}$, Main Output pin is tied to Output Sense pin, Auxiliary Output is programmed for 5V. The main regulator output has a 1 mA load, the auxiliary regulator output has a 100 μA load.

Symbol	Parameter	Conditions	Typical	LP2956AI		LP2956I		Units
				Min	Max	Min	Max	
MAIN OUTPUT								
V_O	Output Voltage		5.0	4.975	5.025	4.950	5.050	V
		$1\ \text{mA} \leq I_L \leq 250\ \text{mA}$	5.0	4.940	5.060	4.900	5.100	
$\frac{\Delta V_O}{\Delta T}$	Temperature Coefficient	(Note 5)	20		100		150	ppm/°C
$\frac{\Delta V_O}{V_O}$	Line Regulation	$V_{IN} = 6\text{V to }30\text{V}$	0.03		0.1		0.2	%
$\frac{\Delta V_O}{V_O}$	Load Regulation	$I_L = 1\ \text{mA to }250\ \text{mA}$	0.04		0.16		0.20	%
		$I_L = 0.1\ \text{mA to }1\ \text{mA}$ (Note 6)			0.20		0.30	
$V_{IN}-V_O$	Dropout Voltage (Note 7)	$I_L = 1\ \text{mA}$	60		100		100	mV
		$I_L = 50\ \text{mA}$	240		300		300	
		$I_L = 100\ \text{mA}$	310		400		400	
		$I_L = 250\ \text{mA}$	470		600		600	
I_{LIMIT}	Current Limit	$R_L = 1\ \Omega$	380		500		500	mA
					530		530	
$\frac{\Delta V_O}{\Delta P_D}$	Thermal Regulation	(Note 8)	0.05		0.2		0.2	%/W
e_n	Output Noise Voltage (10 Hz to 100 KHz) $I_L = 100\ \text{mA}$	$C_L = 2.2\ \mu\text{F}$	400					$\mu\text{V RMS}$
		$C_L = 33\ \mu\text{F}$	260					
		$C_L = 33\ \mu\text{F}$ (Note 9)	80					
V_{FB}	Feedback Pin Voltage		1.23	1.215	1.245	1.205	1.255	V
I_{FB}	Feedback Pin Bias Current		20		40		40	nA
					60		60	
I_O (OFF)	Output Leakage In Shutdown	$I_{(SD\ IN)} \geq 1\ \mu\text{A}$ $V_{IN} = 30\text{V}, V_{OUT} = 0\text{V}$	3		10		10	μA
					20		20	
AUXILIARY OUTPUT								
V_{FB}	Feedback Pin Voltage		1.23	1.22	1.25	1.21	1.26	V

Electrical Characteristics (Continued)

Limits in standard typeface are for $T_J = 25^\circ\text{C}$, and limits in **boldface type** apply over the full operating temperature range. Limits are guaranteed by production testing or correlation techniques using standard Statistical Quality Control (SQC) methods. Unless otherwise specified: $V_{IN} = 6\text{V}$, $C_L = 2.2\ \mu\text{F}$ (Main Output) and $10\ \mu\text{F}$ (Auxiliary Output), Feedback pin is tied to 5V Tap pin, $C_{IN} = 1\ \mu\text{F}$, $V_{SD} = 0\text{V}$, Main Output pin is tied to Output Sense pin, Auxiliary Output is programmed for 5V. The main regulator output has a 1 mA load, the auxiliary regulator output has a 100 μA load.

Symbol	Parameter	Conditions	Typical	LP2956AI		LP2956I		Units
				Min	Max	Min	Max	
AUXILIARY OUTPUT								
				1.21	1.26	1.20	1.27	
$\frac{\Delta V_{FB}}{\Delta T}$	Feedback Voltage Temperature Coefficient		20					ppm/ $^\circ\text{C}$
I_{FB}	Feedback Pin Bias Current		10		20 30		20 30	nA
$\frac{\Delta V_O}{V_O}$	Line Regulation	$6\text{V} \leq V_{IN} \leq 30\text{V}$	0.07		0.3 0.5		0.4 0.6	%
$\frac{\Delta V_O}{V_O}$	Load Regulation	$I_L = 0.1\ \text{mA to } 1\ \text{mA}$ $I_L = 1\ \text{mA to } 75\ \text{mA}$ (Note 10)	0.1		0.3 0.6		0.4 1.0	%
$V_{IN} - V_O$	Dropout Voltage	$I_L = 1\ \text{mA}$	100		200 300		200 300	mV
		$I_L = 50\ \text{mA}$	400		600 700		600 700	mV
		$I_L = 75\ \text{mA}$	500		700 850		700 850	mV
e_n	Output Noise (10 Hz–100 KHz)	$C_L = 10\ \mu\text{F}$	300					$\mu\text{V RMS}$
		$C_L = 33\ \mu\text{F}$ (Note 9)	100					
		$I_L = 10\ \text{mA}$						
I_{LIM}	Current Limit	$V_{OUT} = 0\text{V}$ (Note 13)	80		200 250		200 250	mA
$\frac{\Delta V_O}{\Delta P_D}$	Thermal Regulation	(Note 8)	0.2		0.5		0.5	%/W
DROPOUT DETECTION COMPARATOR								
I_{OH}	Output "HIGH" Leakage	$V_{OH} = 30\text{V}$	0.01		1 2		1 2	μA
V_{OL}	Output "LOW" Voltage	$V_{IN} = 4\text{V}$ I_O (COMP) = 400 μA	150		250 400		250 400	mV
V_{THR} (max)	Upper Threshold Voltage	(Note 11)	-240	-320 -380	-150 -100	-320 -380	-150 -100	mV
V_{THR} (min)	Lower Threshold Voltage	(Note 11)	-350	-450 -640	-230 -160	-450 -640	-230 -160	mV
HYST	Hysteresis	(Note 11)	110					mV
SHUTDOWN INPUT								
I_{IN}	Input Current to Disable Output	(Note 12)	0.03		0.5		0.5	μA
V_{IH}	Shutdown Input High Threshold	$I_{(SD\ IN)} \geq 1\ \mu\text{A}$		900 1200		900 1200		mV
V_{IL}	Shutdown Input Low Threshold	$V_O \geq 4.5\text{V}$			400 200		400 200	mV
AUXILIARY COMPARATOR								
V_T (high)	Upper Trip Point	(Note 14)	1.236	1.20	1.28	1.20	1.28	V

Electrical Characteristics (Continued)

Limits in standard typeface are for $T_J = 25^\circ\text{C}$, and limits in **boldface type** apply over the full operating temperature range. Limits are guaranteed by production testing or correlation techniques using standard Statistical Quality Control (SQC) methods. Unless otherwise specified: $V_{IN} = 6\text{V}$, $C_L = 2.2\ \mu\text{F}$ (Main Output) and $10\ \mu\text{F}$ (Auxiliary Output), Feedback pin is tied to 5V Tap pin, $C_{IN} = 1\ \mu\text{F}$, $V_{SD} = 0\text{V}$, Main Output pin is tied to Output Sense pin, Auxiliary Output is programmed for 5V. The main regulator output has a 1 mA load, the auxiliary regulator output has a 100 μA load.

Symbol	Parameter	Conditions	Typical	LP2956AI		LP2956I		Units
				Min	Max	Min	Max	
AUXILIARY COMPARATOR								
				1.19	1.29	1.19	1.29	
$V_{T(\text{low})}$	Lower Trip Point	(Note 14)	1.230	1.19 1.18	1.27 1.28	1.19 1.18	1.27 1.28	V
HYST	Hysteresis		6					mV
I_{OH}	Output "HIGH" Leakage	$V_{OH} = 30\text{V}$ $V_{IN}(\text{COMP}) = 1.3\text{V}$	0.01		1 2		1 2	μA
V_{OL}	Output "LOW" Voltage	$V_{IN}(\text{COMP}) = 1.1\text{V}$ $I_O(\text{COMP}) = 400\ \mu\text{A}$	150		250 400		250 400	mV
I_B	Input Bias Current	$0 \leq V_{IN}(\text{COMP}) \leq 5\text{V}$	10	-30 -50	30 50	-30 -50	30 50	nA
GROUND PIN CURRENT								
I_{GND}	Ground Pin Current (Note 15)	$I_L(\text{Main Out}) = 1\ \text{mA}$ $I_L(\text{Aux. Out}) = 0.1\ \text{mA}$	170		250 280		250 280	μA
		$I_L(\text{Main Out}) = 50\ \text{mA}$ $I_L(\text{Aux. Out}) = 1\ \text{mA}$	1.1		2 2.5		2 2.5	mA
		$I_L(\text{Main Out}) = 100\ \text{mA}$ $I_L(\text{Aux. Out}) = 1\ \text{mA}$	3		6 8		6 8	
		$I_L(\text{Main Out}) = 250\ \text{mA}$ $I_L(\text{Aux. Out}) = 1\ \text{mA}$	16		28 33		28 33	
		$I_L(\text{Main Out}) = 1\ \text{mA}$ $I_L(\text{Aux. Out}) = 50\ \text{mA}$	3		6 8		6 8	
		$I_L(\text{Main Out}) = 1\ \text{mA}$ $I_L(\text{Aux. Out}) = 75\ \text{mA}$	6		8 10		8 10	
		I_{GND}	Ground Pin Current at Dropout (Note 15)	$V_{IN} = 4.5\text{V}$ $I_L(\text{Main Out}) = 0.1\ \text{mA}$ $I_L(\text{Aux. Out}) = 0.1\ \text{mA}$	270		325 350	
I_{GND}	Ground Pin Current at Shutdown (Note 15)	No Load on Either Output $I_{(SD\ IN)} \geq 1\ \mu\text{A}$	120		180 200		180 200	

Note 1: Absolute maximum ratings indicate limits beyond which damage to the component may occur. Electrical specifications do not apply when operating the device outside of its rated operating conditions.

Note 2: The maximum allowable power dissipation is a function of the maximum junction temperature, $T_{J(\text{max})}$, the junction-to-ambient thermal resistance, θ_{JA} , and the ambient temperature, T_A . The maximum allowable power dissipation at any ambient temperature is calculated using: $P(\text{max}) =$

$$P(\text{max}) = \frac{T_{J(\text{max})} - T_A}{\theta_{JA}}$$

Exceeding the maximum allowable power dissipation will cause excessive die temperature, and the regulator will go into thermal shutdown. See Application Hints for additional information on heat sinking and thermal resistance.

Note 3: When used in dual-supply systems where the regulator load is returned to a negative supply, the output voltage must be diode-clamped to ground.

Note 4: May exceed the input supply voltage.

Note 5: Output or reference voltage temperature coefficient is defined as the worst case voltage change divided by the total temperature range.

Note 6: Load regulation is measured at constant junction temperature using low duty cycle pulse testing. Two separate tests are performed, one for the range of 100 μA to 1 mA and one for the 1 mA to 250 mA range. Changes in output voltage due to heating effects are covered by the thermal regulation specification.

Note 7: Dropout voltage is defined as the input to output differential at which the output voltage drops 100 mV below the value measured with a 1V differential. At very low values of programmed output voltage, the input voltage minimum of 2V (2.3V over temperature) must be observed.

Electrical Characteristics (Continued)

Note 8: Thermal regulation is the change in output voltage at a time T after a change in power dissipation, excluding load or line regulation effects. Specifications are for a 200 mA load pulse at $V_{IN} = 20V$ (3W pulse) for $T = 10$ ms on the Main regulator output. For the Auxiliary regulator output, specifications are for a 66 mA load pulse at $V_{IN} = 20V$ (1W pulse) for $T = 10$ ms.

Note 9: Connect a 0.1 μF capacitor from the output to the feedback pin.

Note 10: Load regulation is measured at constant junction temperature using low duty cycle pulse testing. Two separate tests are performed, one for the range of 100 μA to 1 mA and one for the 1 mA to 75 mA range. Changes in output voltage due to heating effects are covered by the thermal regulation specification.

Note 11: Dropout detection comparator thresholds are expressed as changes in a 5V output. To express the threshold voltages in terms of a differential at the Feedback terminal, divide by the error amplifier gain = V_{OUT}/V_{REF} .

Note 12: The shutdown input equivalent circuit is the base of a grounded-emitter NPN transistor in series with a current-limiting resistor. Pulling the shutdown input high turns off the main regulator. For more details, see Application Hints.

Note 13: The auxiliary regulator output has foldback limiting, which means the output current reduces with output voltage. The tested limit is for $V_{OUT} = 0V$, so the output current will be higher at higher output voltages.

Note 14: This test is performed with the auxiliary comparator output sinking 400 μA of current. At the upper trip point, the comparator output must be $\geq 2.4V$. At the low trip point, the comparator output must be $\leq 0.4V$.

Note 15: Ground pin current is the regulator quiescent current. The total current drawn from the source is the sum of the ground pin current, output load current, and current through the external resistive dividers (if used).

Note 16: All pins are rated for 2 kV, except for the auxiliary feedback pin which is rated for 1.2 kV (human body model, 100 pF discharged through 1.5 k Ω).

Typical Performance Characteristics

Unless otherwise specified: $V_{IN} = 6V$, $C_L = 2.2 \mu F$ (Main Output) and 10 μF (Auxiliary Output), Feedback is tied to 5V Tap pin, $C_{IN} = 1 \mu F$, $V_{SD} = 0V$, Main Output pin is tied to Output Sense pin, Auxiliary Output is programmed for 5V. The main regulator output has a 1 mA load, the auxiliary output has a 100 μA load.

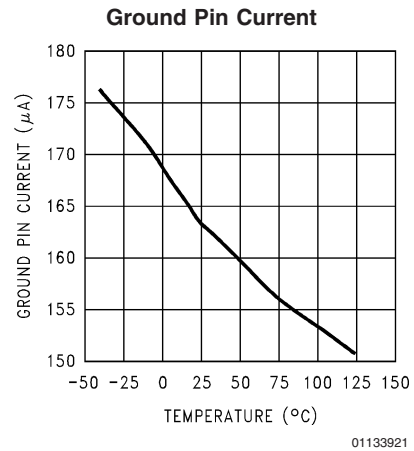
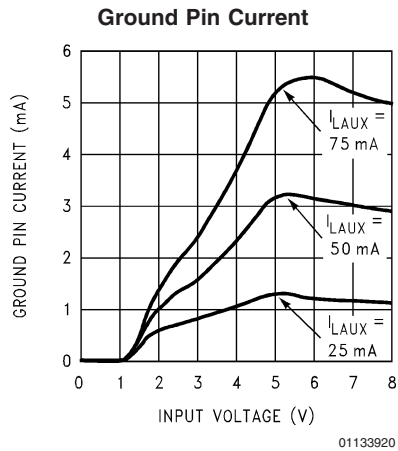
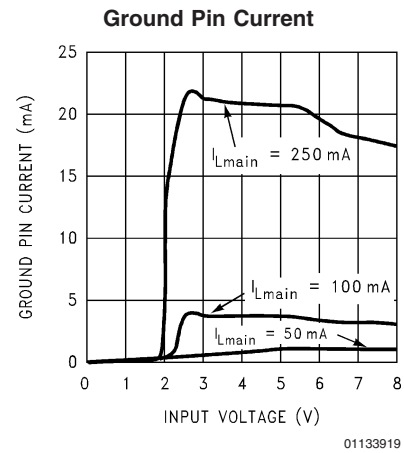
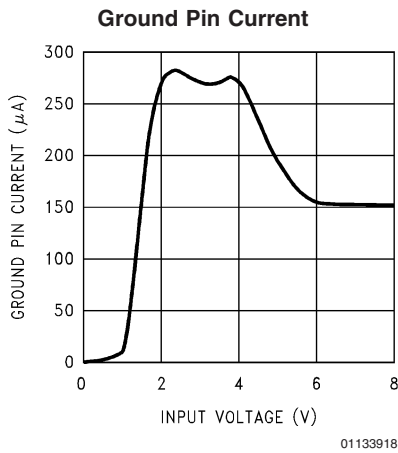

Typical Performance Characteristics Unless otherwise specified: $V_{IN} = 6V$, $C_L = 2.2 \mu F$ (Main Output) and $10 \mu F$ (Auxiliary Output), Feedback is tied to 5V Tap pin, $C_{IN} = 1 \mu F$, $V_{SD} = 0V$, Main Output pin is tied to Output Sense pin, Auxiliary Output is programmed for 5V. The main regulator output has a 1 mA load, the auxiliary output has a 100 μA load. (Continued)

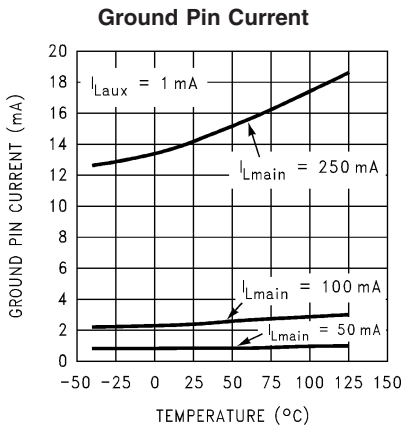

01133922

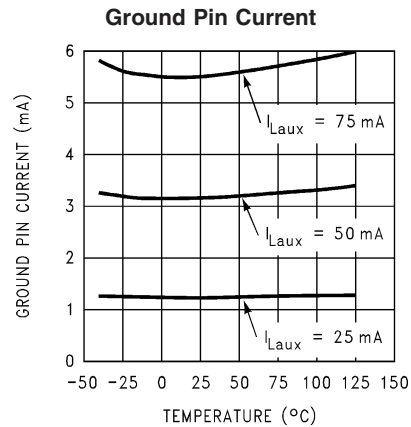

01133923

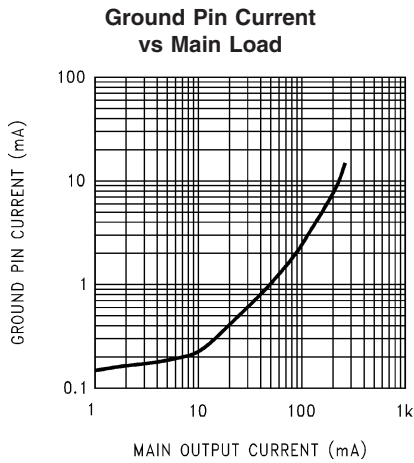

01133924

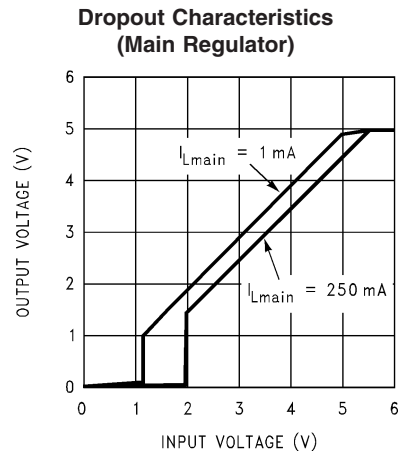

01133925

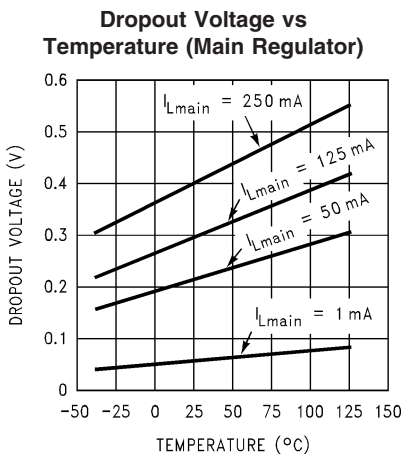

01133926

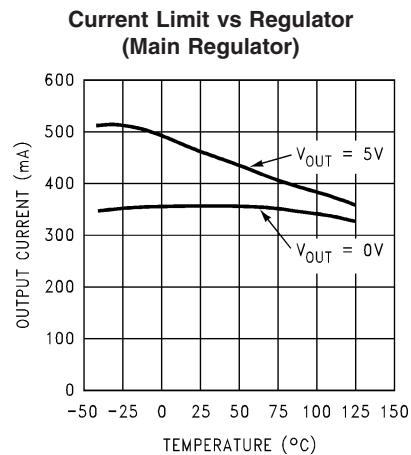

01133927

Typical Performance Characteristics Unless otherwise specified: $V_{IN} = 6V$, $C_L = 2.2 \mu F$ (Main Output) and $10 \mu F$ (Auxiliary Output), Feedback is tied to 5V Tap pin, $C_{IN} = 1 \mu F$, $V_{SD} = 0V$, Main Output pin is tied to Output Sense pin, Auxiliary Output is programmed for 5V. The main regulator output has a 1 mA load, the auxiliary output has a 100 μA load. (Continued)

Enable Transient (Main Regulator)

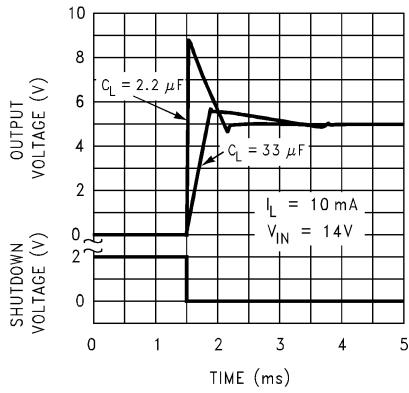

01133928

Enable Transient (Main Regulator)

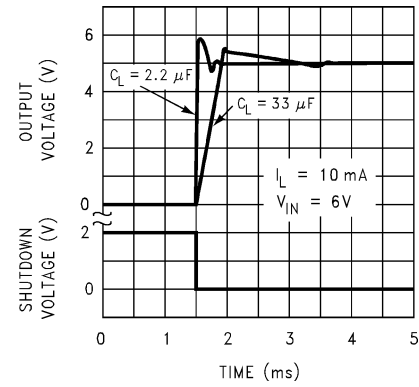

01133929

Load Transient Response (Main Regulator)

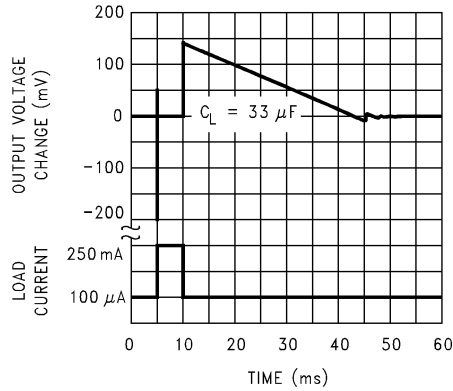

01133930

Load Transient Response (Main Regulator)

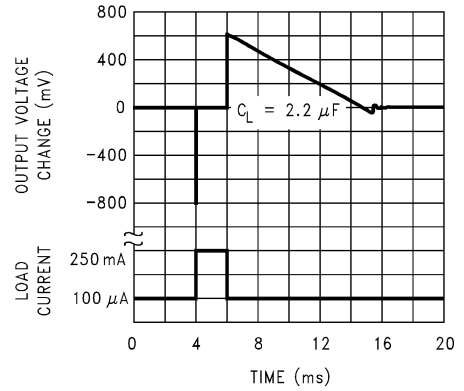

01133931

Line Transient Response (Main Regulator)

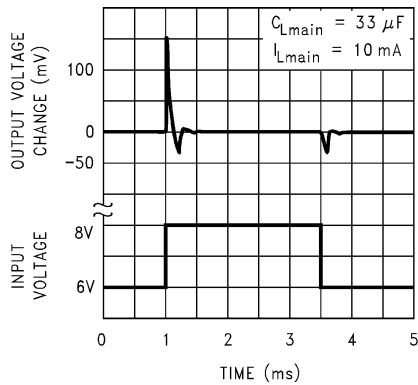

01133932

Line Transient Response (Main Regulator)

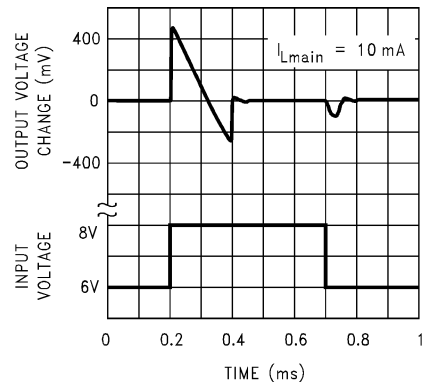

01133933

Typical Performance Characteristics Unless otherwise specified: $V_{IN} = 6V$, $C_L = 2.2 \mu F$ (Main Output) and $10 \mu F$ (Auxiliary Output), Feedback is tied to 5V Tap pin, $C_{IN} = 1 \mu F$, $V_{SD} = 0V$, Main Output pin is tied to Output Sense pin, Auxiliary Output is programmed for 5V. The main regulator output has a 1 mA load, the auxiliary output has a 100 μA load. (Continued)

Ripple Rejection (Main Regulator)

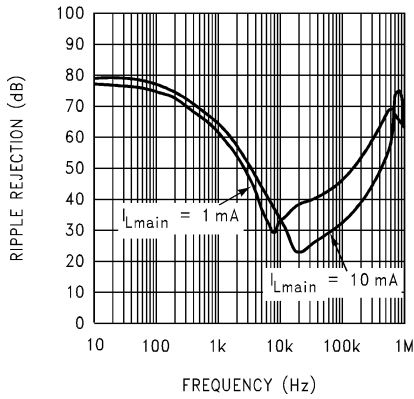

01133934

Ripple Rejection (Main Regulator)

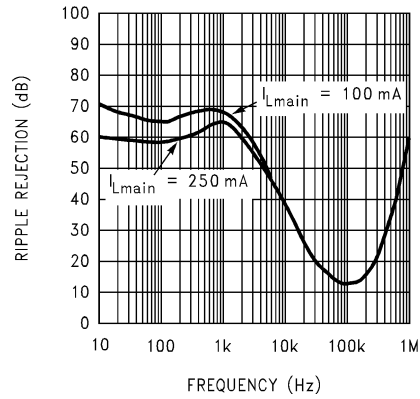

01133935

Ripple Rejection (Main Regulator)

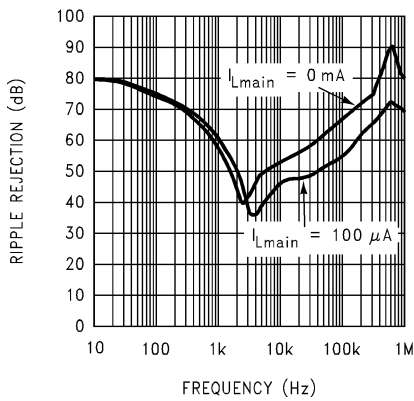

01133936

Thermal Regulation (Main Regulator)

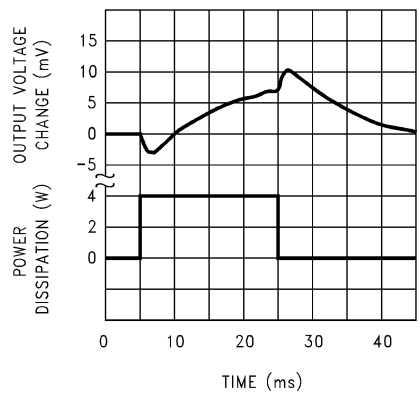

01133937

Output Impedance (Main Regulator)

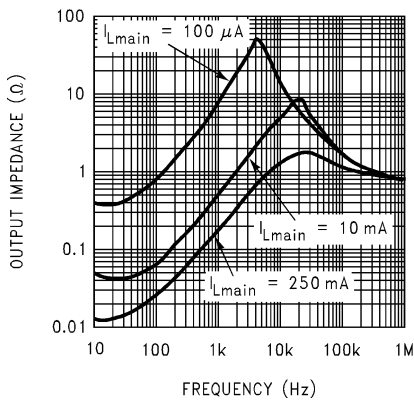

01133938

Output Noise Voltage (Main Regulator)

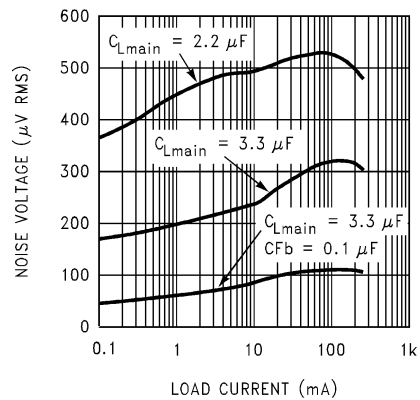

01133939

Typical Performance Characteristics Unless otherwise specified: $V_{IN} = 6V$, $C_L = 2.2 \mu F$ (Main Output) and $10 \mu F$ (Auxiliary Output), Feedback is tied to 5V Tap pin, $C_{IN} = 1 \mu F$, $V_{SD} = 0V$, Main Output pin is tied to Output Sense pin, Auxiliary Output is programmed for 5V. The main regulator output has a 1 mA load, the auxiliary output has a 100 μA load. (Continued)

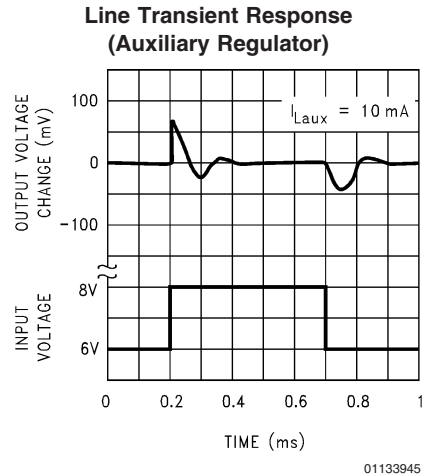
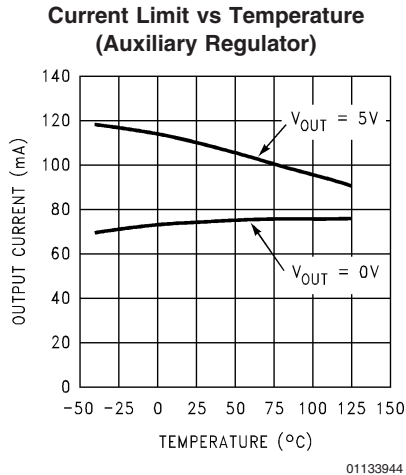
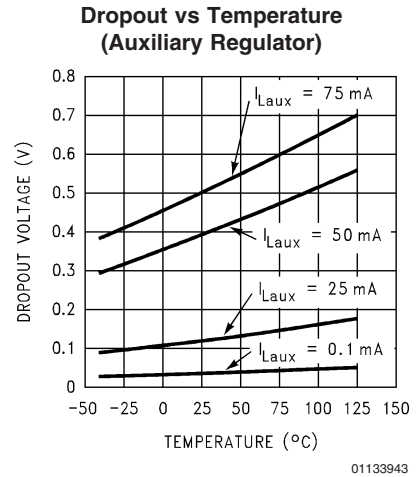
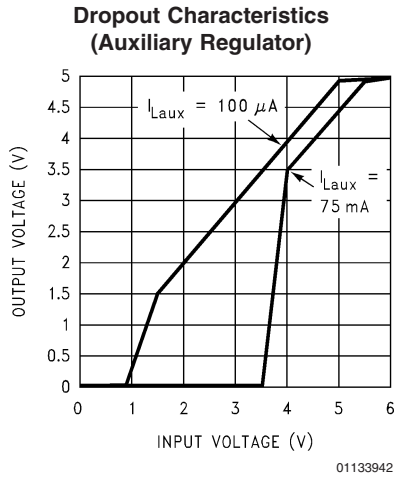
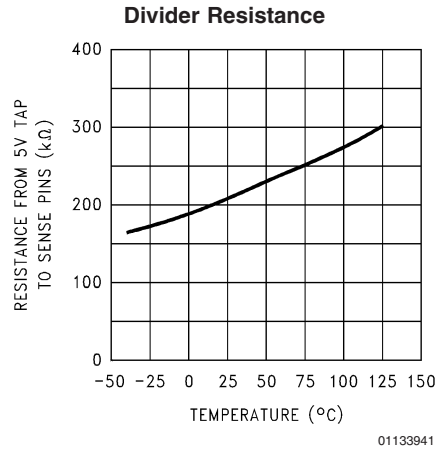
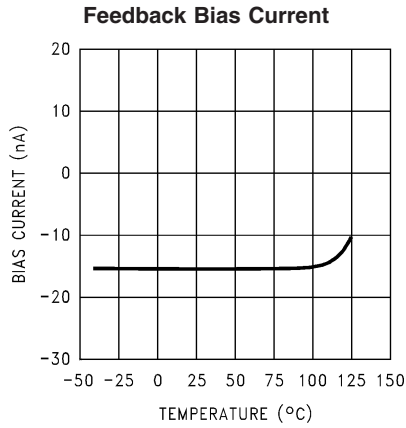

Typical Performance Characteristics Unless otherwise specified: $V_{IN} = 6V$, $C_L = 2.2 \mu F$ (Main Output) and $10 \mu F$ (Auxiliary Output), Feedback is tied to 5V Tap pin, $C_{IN} = 1 \mu F$, $V_{SD} = 0V$, Main Output pin is tied to Output Sense pin, Auxiliary Output is programmed for 5V. The main regulator output has a 1 mA load, the auxiliary output has a 100 μA load. (Continued)

Load Transient Response (Auxiliary Regulator)

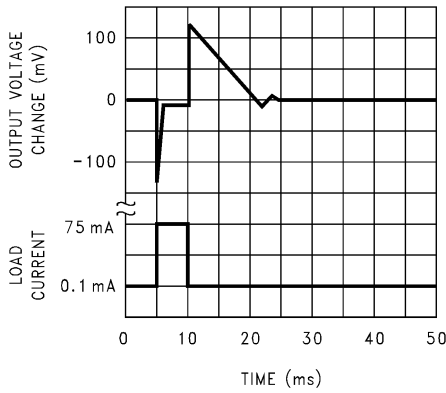

01133946

Load Transient Response (Auxiliary Regulator)

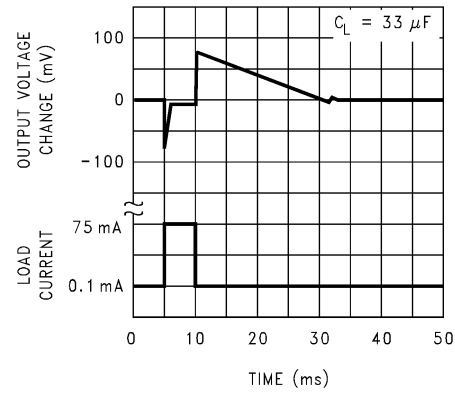

01133947

Ripple Rejection (Auxiliary Regulator)

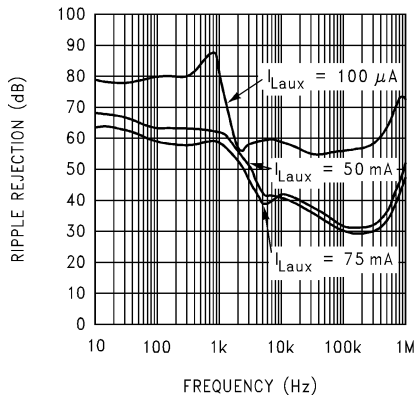

01133948

Output Impedance (Auxiliary Regulator)

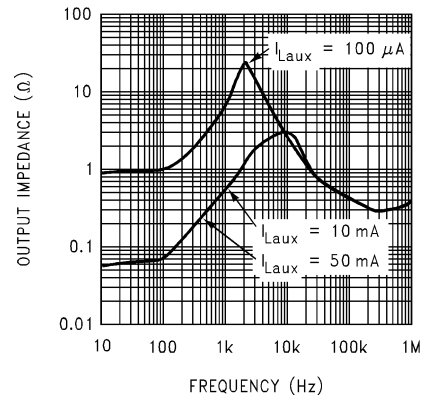

01133949

Output Noise Voltage (Auxiliary Regulator)

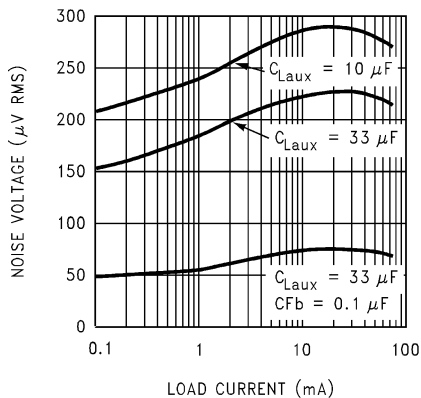

01133950

Auxiliary Comparator Sink Current

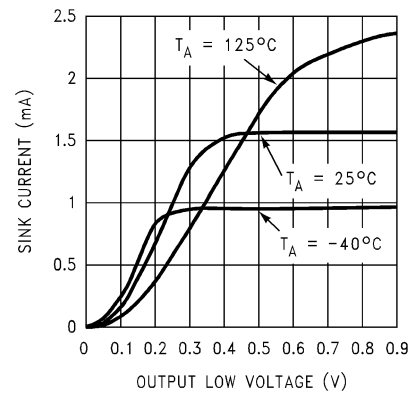

01133951

Typical Performance Characteristics Unless otherwise specified: $V_{IN} = 6V$, $C_L = 2.2 \mu F$ (Main Output) and $10 \mu F$ (Auxiliary Output), Feedback is tied to 5V Tap pin, $C_{IN} = 1 \mu F$, $V_{SD} = 0V$, Main Output pin is tied to Output Sense pin, Auxiliary Output is programmed for 5V. The main regulator output has a 1 mA load, the auxiliary output has a 100 μA load. (Continued)

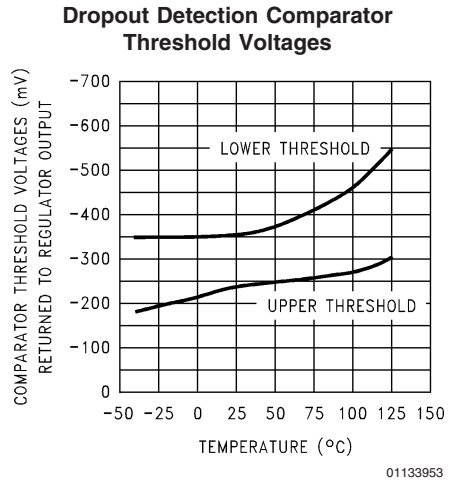
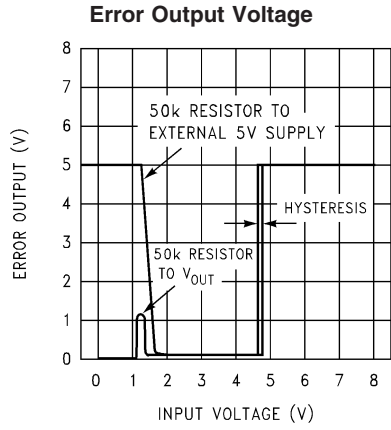

Application Hints

HEATSINK REQUIREMENTS

A heatsink may be required with the LP2956 depending on the maximum power dissipation and maximum ambient temperature of the application. Under all expected operating conditions, the junction temperature must be within the range specified under Absolute Maximum Ratings.

To determine if a heatsink is required, the maximum power dissipated by the regulator, P(max), must be calculated. It is important to remember that if the regulator is powered from a transformer connected to the AC line, the **maximum specified AC input voltage** must be used (since this produces the maximum DC input voltage to the regulator). *Figure 1* shows the voltages and currents which are present in the circuit. The formula for calculating the power dissipated in the regulator is also shown in *Figure 1* (the currents and power due to external resistive dividers are not included, and are typically negligible).

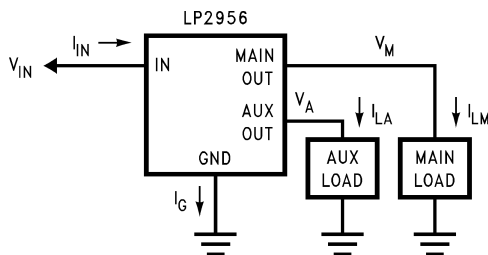

$$P_{TOTAL} = (V_{IN} - V_M) I_{LM} + (V_{IN} - V_A) I_{LA} + (V_{IN}) I_G$$

FIGURE 1. Current/Voltage Diagram

The next parameter which must be calculated is the maximum allowable temperature rise, T_R(max). This is calculated by using the formula:

$$T_R(max) = T_J(max) - T_A(max)$$

where: T_J(max) is the maximum allowable junction temperature

T_A(max) is the maximum ambient temperature

Using the calculated values for T_R(max) and P(max), the required value for junction-to-ambient thermal resistance, θ_(J-A), can now be found:

$$\theta_{(J-A)} = T_R(max)/P(max)$$

The heatsink for the LP2956 is made using the PC board copper. The heat is conducted from the die, through the lead frame (inside the part), and out the pins which are soldered to the PC board. The pins used for heat conduction are shown in *Table 1*.

TABLE 1.

Part	Package	Pins
LP2956IN	16-Pin Plastic DIP	4, 5, 12, 13
LP2956AIN	16-Pin Plastic DIP	4, 5, 12, 13
LP2956IM	16-Pin Surface Mt.	1, 8, 9, 16
LP2956AIM	16-Pin Surface Mt.	1, 8, 9, 16

Figure 2 shows copper patterns which may be used to dissipate heat from the LP2956:

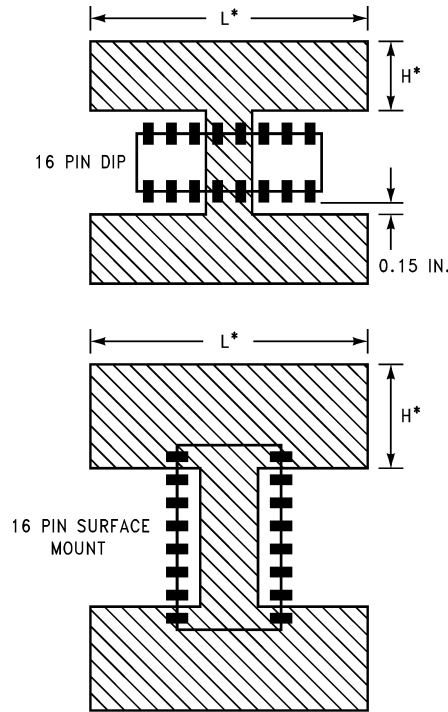

*For best results, use L = 2H

01133910

FIGURE 2. Copper Heatsink Patterns

Table 2 shows some typical values of junction-to-ambient thermal resistance (θ_{J-A}) for values of L and W (1 oz. copper).

TABLE 2.

Package	L (In.)	H (In.)	θ _{J-A} (°C/W)
16-Pin Plastic DIP	1	0.5	70
	2	1	60
	3	1.5	58
	4	0.19	66
	6	0.19	66
16-Pin Surface Mount	1	0.5	83
	2	1	70
	3	1.5	67
	6	0.19	69
	4	0.19	71
	2	0.19	73

EXTERNAL CAPACITORS

A 2.2 μF (or greater) capacitor is required between the main output pin and ground to assure stability. The auxiliary output requires 10 μF to ground. Without these capacitors, the part may oscillate. Most types of tantalum or aluminum electrolytics will work here. Film types will work, but are more expensive. Many aluminum electrolytics contain electrolytes which freeze at -30°C, which requires the use of solid tantalums below -25°C. The important characteristic of the capacitors is an ESR of 5Ω (or less) on the main regulator

Application Hints (Continued)

output and an ESR of 1Ω (or less) on the auxiliary regulator output (the ESR may increase by a factor of **20** or **30** as the temperature is reduced from +25°C to -30°C). The value of these capacitors may be increased without limit.

The main output requires less capacitance at lighter load currents. This capacitor can be reduced to 0.68 μF for currents below 10 mA or 0.22 μF for currents below 1 mA.

Programming the main output for voltages below 5V requires *more* output capacitance for stability. For the worst-case condition of 1.23V output and 250 mA of load current, a 6.8 μF (or larger) capacitor should be used.

A 1 μF capacitor should be placed from the input pin to ground if there is more than 10 inches of wire between the input and the AC filter capacitor or if a battery input is used.

Stray capacitance to the Feedback terminal can cause instability. This problem is most likely to appear when using high value external resistors to set the output voltage. Adding a 100 pF capacitor between the Output and Feedback pins and increasing the output capacitance to 6.8 μF (or greater) will cure the problem.

MINIMUM LOAD ON MAIN OUTPUT

When setting the main output voltage using an external resistive divider, a minimum current of 10 μA is recommended through the resistors to provide a minimum load.

It should be noted that a minimum load current is specified in several of the electrical characteristic test conditions, so the specified value must be used to obtain test limit correlation.

PROGRAMMING THE MAIN OUTPUT VOLTAGE

The main output may be pin-strapped for 5V operation using its internal resistive divider by tying the Output and Sense pins together and also tying the Feedback and 5V Tap pins together.

Alternatively, it may be programmed for any voltage between the 1.23V reference and the 29V maximum rating using an external pair of resistors (see *Figure 3*). The complete equation for the output voltage is:

$$V_{\text{MAIN OUT}} = V_{\text{REF}} \times \left(1 + \frac{R1}{R2} \right) + (I_{\text{FB}} \times R1)$$

where V_{REF} is the 1.23V reference and I_{FB} is the Feedback pin bias current (-20 nA typical). The minimum recommended load current of 1 μA sets an upper limit of 1.2 MΩ on the value of R2 in cases where the regulator must work with no load (see **MINIMUM LOAD**).

If I_{FB} is ignored in the calculation of the output voltage, it will produce a small error in $V_{\text{MAIN OUT}}$. Choosing $R2 = 100 \text{ k}\Omega$ will reduce this error to 0.16% (typical) while increasing the resistor program current to 12 μA. Since the typical quiescent current is 130 μA, this added current is negligible.

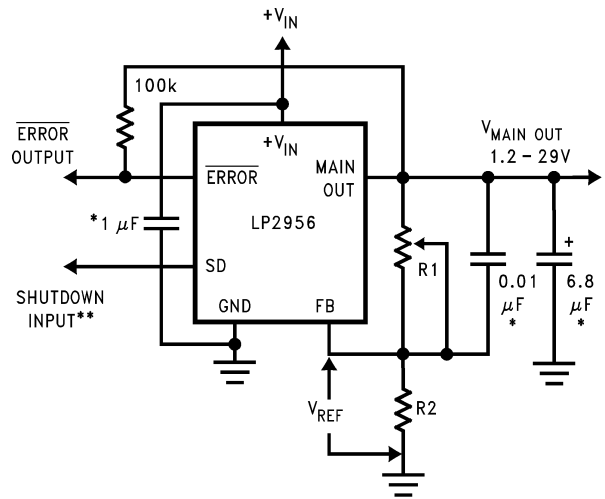

01133911

*See Application Hints

**Drive with high to shut down

FIGURE 3. Adjustable Regulator

DROPOUT VOLTAGE

The dropout voltage of the regulator is defined as the minimum input-to-output voltage differential required for the output voltage to stay within 100 mV of the output voltage measured with a 1V differential. The dropout voltage is independent of the programmed output voltage.

DROPOUT DETECTION COMPARATOR

This comparator produces a logic “LOW” whenever the main output falls out of regulation by more than about 5%. This figure results from the comparator’s built-in offset of 60 mV divided by the 1.23V reference (refer to block diagram). The 5% low trip level remains constant regardless of the programmed output voltage. An out-of-regulation condition can result from low input voltage, current limiting, or thermal limiting.

Figure 4 gives a timing diagram showing the relationship between the main output voltage, the $\overline{\text{ERROR}}$ output, and input voltage as the input voltage is ramped up and down to a regulator whose main output is programmed for 5V. The $\overline{\text{ERROR}}$ signal becomes low at about 1.3V input. It goes high at about 5V input, where the main output equals 4.75V. Since the dropout voltage is load dependent, the **input** voltage trip points will vary with load current. The **main output** voltage trip point does not vary.

The comparator has an open-collector output which requires an external pull-up resistor. This resistor may be connected to the regulator main output or some other supply voltage. Using the main output prevents an invalid “HIGH” on the comparator output which occurs if it is pulled up to an external voltage while the regulator input voltage is reduced below 1.3V. In selecting a value for the pull-up resistor, note that while the output can sink 400 μA, this current adds to battery drain. Suggested values range from 100 kΩ to 1 MΩ. The resistor is not required if the output is unused.

Application Hints (Continued)

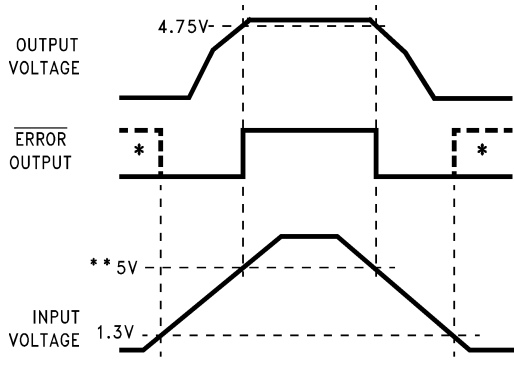

*In shutdown mode, $\overline{\text{ERROR}}$ will go high if it has been pulled up to an external supply. To avoid this invalid response, pull up to regulator output
 **Exact value depends on dropout voltage. (See Application Hints)

FIGURE 4. $\overline{\text{ERROR}}$ Output Timing

If a single pull-up resistor is used to the regulator output, the error flag may briefly rise up to about 1.3V as the input voltage ramps up or down through the 0V to 1.3V region.

In some cases, this 1.3V signal may be mis-interpreted as a false high by a μP which is still "alive" with 1.3V applied to it.

To prevent this, the user may elect to use **two** resistors which are equal in value on the error output (one connected to ground and the other connected to the regulator output).

If this two-resistor divider is used, the error output will only be pulled up to about 0.6V (not 1.3V) during power-up or power-down, so it can not be interpreted as a high signal. When the regulator output is at 5V, the error output will be 2.5V, which is still clearly a high signal.

OUTPUT ISOLATION

The regulator outputs can be left connected to an active voltage source (such as a battery) with the regulator input power shut off, as long as the regulator ground pin is connected to ground. If the ground pin is left floating, damage to the regulator can occur if the output is pulled up by an external voltage source.

REDUCING MAIN OUTPUT NOISE

In reference applications it may be advantageous to reduce the AC noise present on the main output. One method is to reduce regulator bandwidth by increasing output capacitance. This is relatively inefficient, since large increases in capacitance are required to get significant improvement.

Noise can be reduced more effectively by a bypass capacitor placed across R_1 (refer to *Figure 3*). The formula for selecting the capacitor to be used is:

$$C_B = \frac{1}{2\pi R_1 \times 20 \text{ Hz}}$$

This gives a value of about 0.1 μF . When this is used, the output capacitor must be 6.8 μF (or greater) to maintain stability. The 0.1 μF capacitor reduces the high frequency noise gain of the circuit to unity, lowering the output noise from 260 μV to 80 μV using a 10 Hz to 100 kHz bandwidth.

Also, noise is no longer proportional to the output voltage, so improvements are more pronounced at higher output voltages.

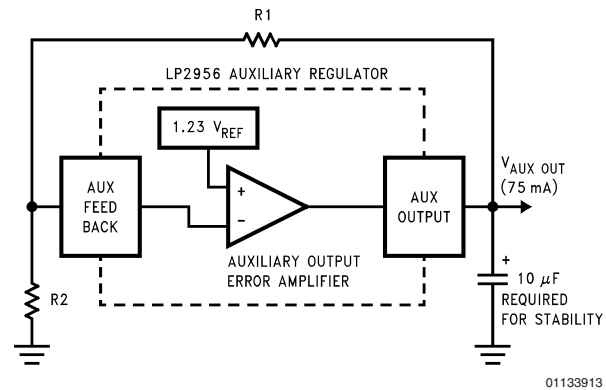

$$V_{\text{AUX OUT}} = V_{\text{REF}} \left(1 + \frac{R_1}{R_2} \right) + (I_{\text{FB}} \times R_1)$$

where: $V_{\text{REF}} = 1.23\text{V}$ and $I_{\text{FB}} = -10 \text{ nA}$ (typical)

FIGURE 5. Auxiliary Adjustable Regulator

AUXILIARY LDO OUTPUT

The LP2956 has an auxiliary LDO regulator output (which can source up to 75 mA) that is adjustable for voltages from 1.23V to 29V.

The output voltage is set by an external resistive divider, as shown in *Figure 5*. The maximum output current is 75 mA, and the output requires 10 μF from the output to ground for stability, regardless of load current.

SHUTDOWN INPUT

The shutdown input equivalent circuit is shown in *Figure 6*. The main regulator output is shut down when the NPN transistor is turned ON.

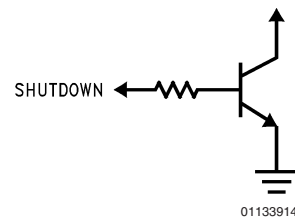

FIGURE 6. Shutdown Circuitry

The current into the input should be at least 0.5 μA to assure the output shutdown function. A resistor may be placed in series with the input to minimize current draw in shutdown mode, provided this minimum input current requirement is met.

IMPORTANT:

The shutdown input must not be left floating: a pull-down resistor (10 k Ω to 50 k Ω recommended) must be connected between the shutdown input and ground in cases where the input is not actively pulled low.

Schematic Diagram

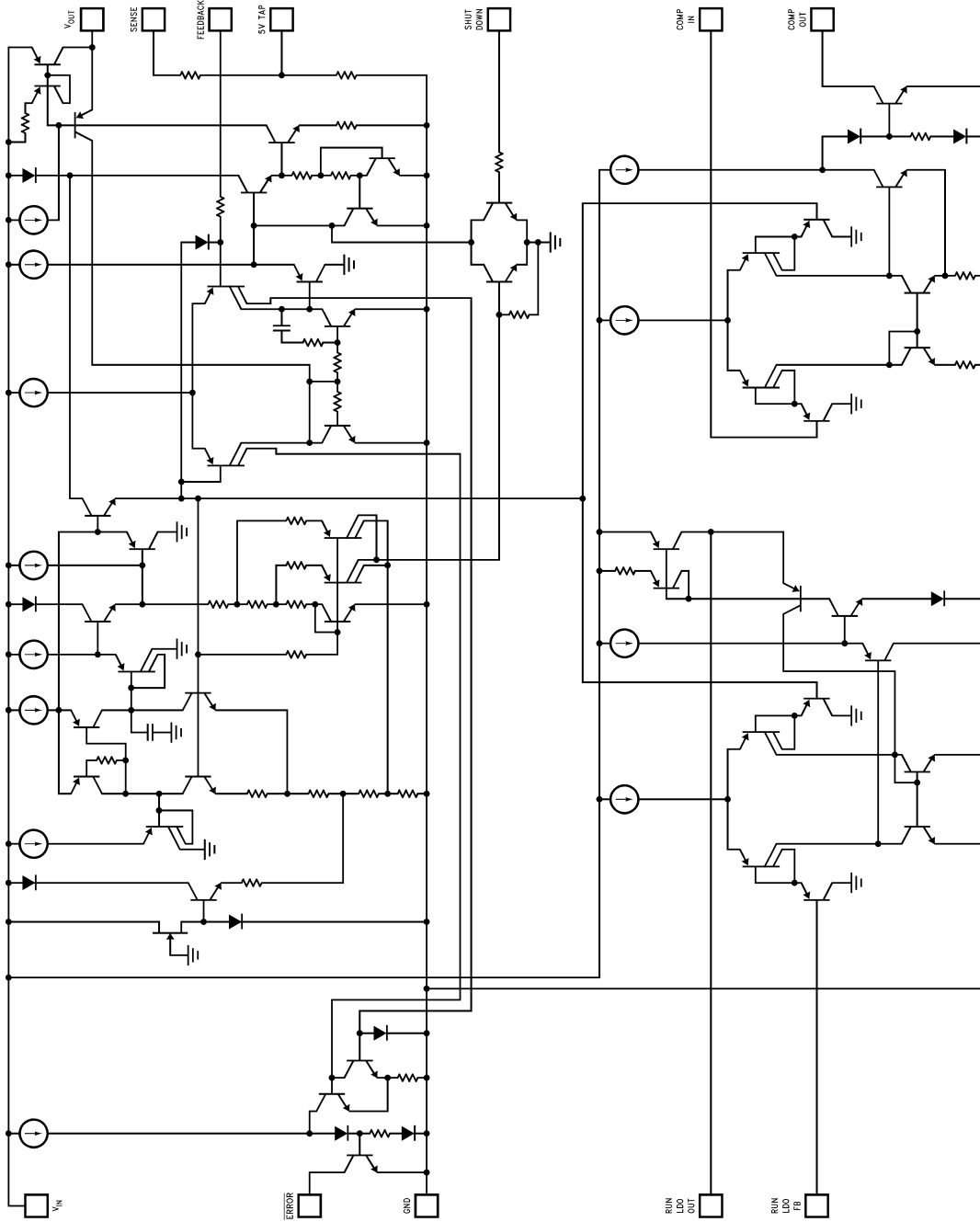

01133915

Typical Applications

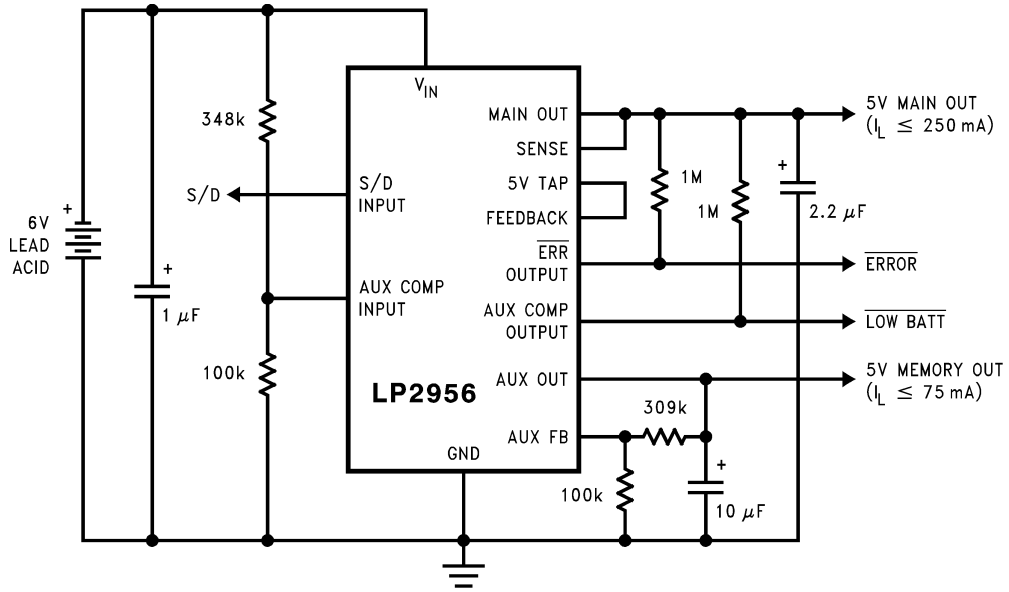

01133916

Physical Dimensions inches (millimeters)

unless otherwise noted

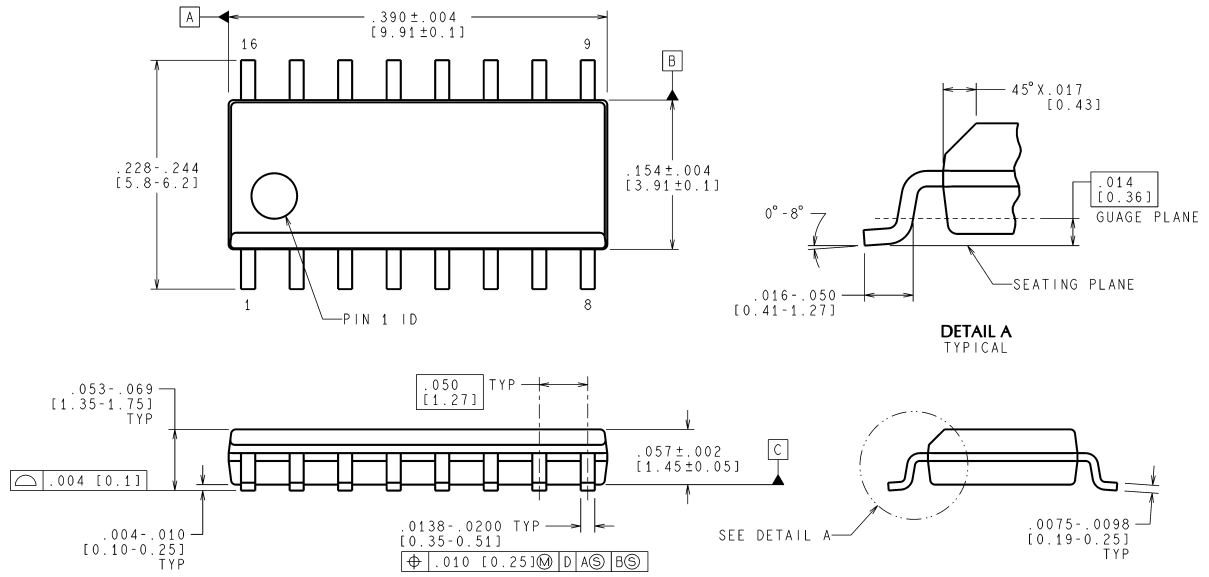

CONTROLLING DIMENSION IS INCH
VALUES IN [] ARE MILLIMETERS

M16A (Rev J)

16-Pin Surface Mount
Order Number LP2956IM or LP2956AIM
NS Package Number M16A

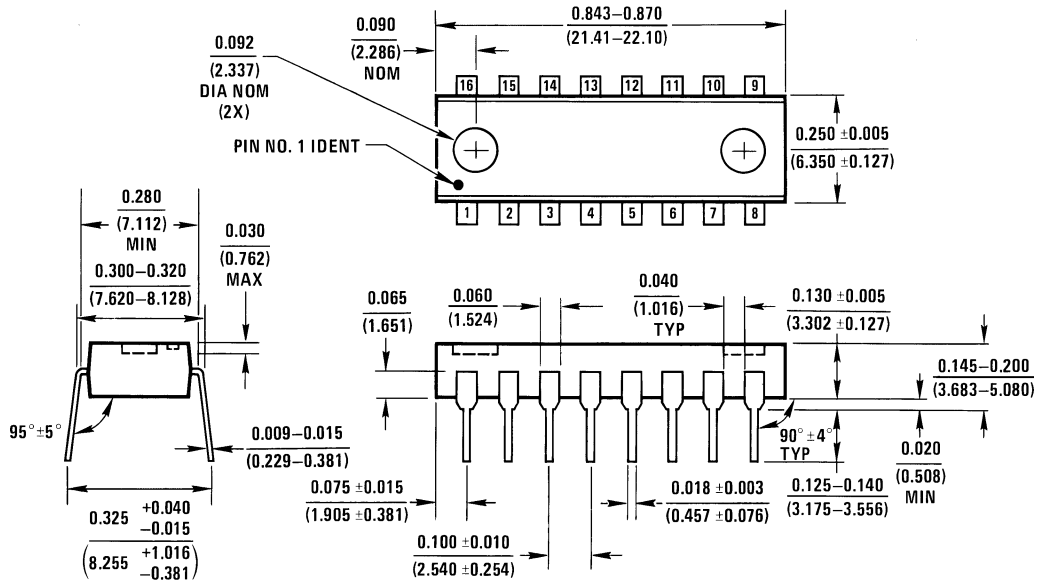

N16A (REV E)

16-Pin Plastic Dual-In-Line Package
Order Number LP2956IN or LP2956AIN
NS Package Number N16A

Physical Dimensions inches (millimeters) unless otherwise noted (Continued)

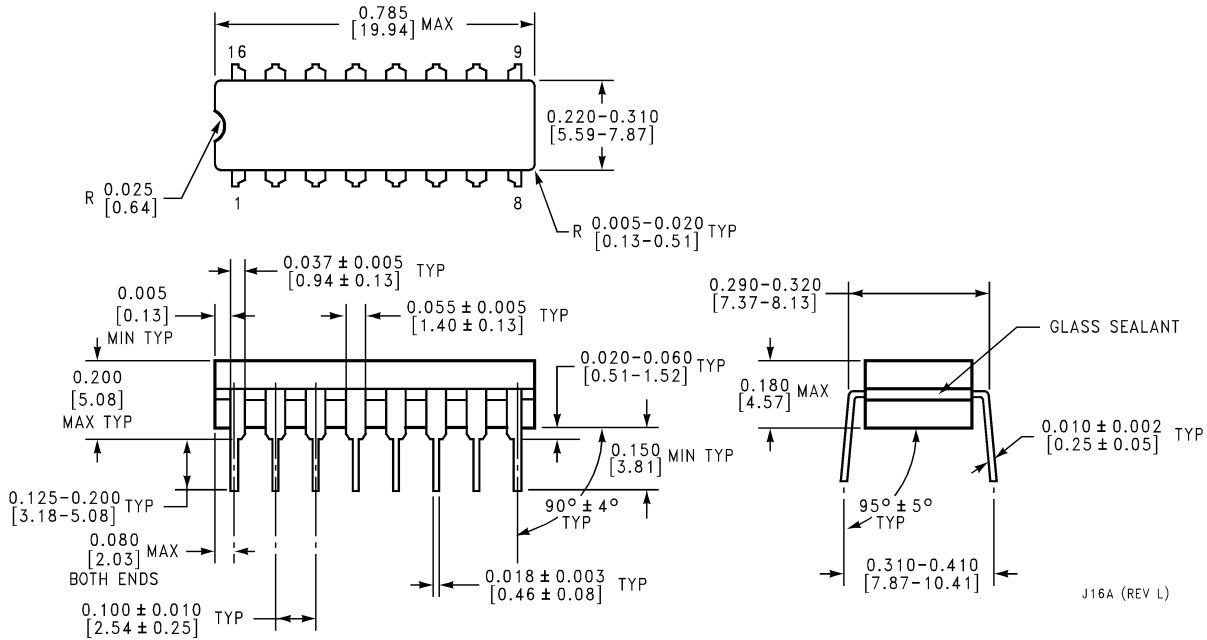

16-Pin Ceramic Dual-In-Line Package
Order Number LP2956AMJ-QML or 5962-9554701QEA
NS Package Number J16A

National does not assume any responsibility for use of any circuitry described, no circuit patent licenses are implied and National reserves the right at any time without notice to change said circuitry and specifications.

For the most current product information visit us at www.national.com.

LIFE SUPPORT POLICY

NATIONAL'S PRODUCTS ARE NOT AUTHORIZED FOR USE AS CRITICAL COMPONENTS IN LIFE SUPPORT DEVICES OR SYSTEMS WITHOUT THE EXPRESS WRITTEN APPROVAL OF THE PRESIDENT AND GENERAL COUNSEL OF NATIONAL SEMICONDUCTOR CORPORATION. As used herein:

1. Life support devices or systems are devices or systems which, (a) are intended for surgical implant into the body, or (b) support or sustain life, and whose failure to perform when properly used in accordance with instructions for use provided in the labeling, can be reasonably expected to result in a significant injury to the user.
2. A critical component is any component of a life support device or system whose failure to perform can be reasonably expected to cause the failure of the life support device or system, or to affect its safety or effectiveness.

BANNED SUBSTANCE COMPLIANCE

National Semiconductor manufactures products and uses packing materials that meet the provisions of the Customer Products Stewardship Specification (CSP-9-111C2) and the Banned Substances and Materials of Interest Specification (CSP-9-111S2) and contain no "Banned Substances" as defined in CSP-9-111S2.



National Semiconductor
Americas Customer Support Center
 Email: new.feedback@nsc.com
 Tel: 1-800-272-9959

National Semiconductor
Europe Customer Support Center
 Fax: +49 (0) 180-530 85 86
 Email: europe.support@nsc.com
 Deutsch Tel: +49 (0) 69 9508 6208
 English Tel: +44 (0) 870 24 0 2171
 Français Tel: +33 (0) 1 41 91 8790

National Semiconductor
Asia Pacific Customer Support Center
 Email: ap.support@nsc.com

National Semiconductor
Japan Customer Support Center
 Fax: 81-3-5639-7507
 Email: jpn.feedback@nsc.com
 Tel: 81-3-5639-7560